

Authorized Dealer

# Portfolio



**3form** Elements



# Table of Contents

<b>Introduction</b>	02
We are 3form, and we believe in smart design for a better world.	
<b>Reception Kiosks</b>	14
Make a first impression with these remarkable reception desks.	
<b>Space Division</b>	28
Design and organize built environments with these workspace solutions.	
<b>Acoustic Solutions</b>	68
Improve the acoustics of your space with beautiful absorptive solutions.	
<b>Wall &amp; Ceiling Solutions</b>	94
Redefine walls and ceilings with customizable products waiting for your creative touch.	
<b>Tabletops</b>	106
Create beautiful and highly durable solutions for horizontal surfaces.	
<b>Markerboards</b>	112
Add function to your workspace with magnetic, writeable surfaces.	
<b>Design Choices</b>	128
Choose your material, pattern, and color.	



We are trailblazers of awesomeness. We are craftsmen of cool. We do stuff that matters, and we're stoked out of our brains about it. We do mindblowing things with form, texture, and light with a maniacal sense of urgency. We are passionate about our people and our planet.

We are **3form**





Product | 200.86 Pattern | Lina Color | Tans

## Smart Design for a Better World

We believe design matters.  
We believe in the highest level of craft.  
We believe in supporting those who create it.  
We believe in better ways to make better products.  
We believe in promoting a healthy, active lifestyle.  
We believe in taking care of the planet.  
We believe in social responsibility.

Visit [3-form.com/inspiration/we-are-3form](https://3-form.com/inspiration/we-are-3form) to learn more.







## align

We believe it's imperative to align the creation of beautifully designed products with actions and practices that help protect and nourish the planet. At the 3form family of companies (3form, LightArt, and EFI), these actions and practices are collectively called Align — our platform of Earth and people-centric initiatives that will guide our path forward.

Three main pillars – **people, product, planet** – provide the framework for Align. These pillars translate into a focus on human well-being alongside design methods and manufacturing processes that conserve and restore the planet.

*Learn more about our specific actions at [3form.com/align](https://3form.com/align)*



## Responsible Manufacturing

We create products from the highest quality materials that contribute to positive environmental and social impact. We start by measuring and reporting our environmental impact through life cycle analyses and third-party verifications.

- Leader of the Living Future Institute's Declare label
- Environmental Product Declarations (EPD's)
- Health Product Declarations (HPD's)

Visit [3-form.com](https://3-form.com) to see additional details.

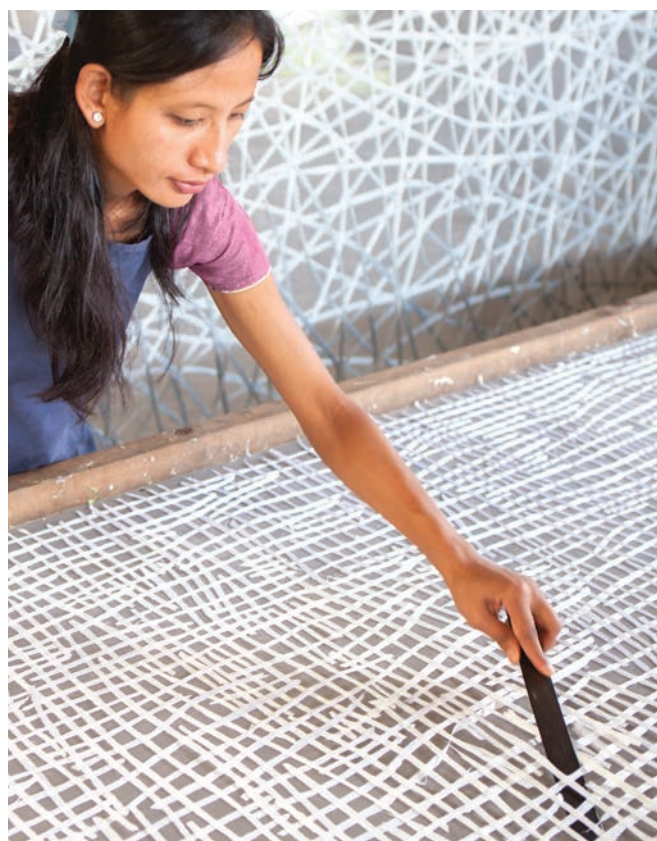

Product | 200.86 Pattern | Connection Square Color | Pure





# Flek Innovative Engineering

Our latest material innovation, Flek, is one example of Align in action. More than ten years of R&D and the use of optical sorting technology made this sustainable material possible. We take waste material from the production process of Varia panels, grind it into small pellets, sort out remnants of interlayers, and press the pellets into new, beautiful Flek panels with approximately 75% recycled material.

See page 128 for all Flek colors.

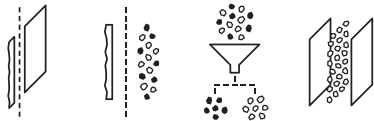

Product | 200.59 Pattern | Flek Avenue Hardware | Carbide

Pattern | Flek Chamomile, Avenue, Blood Orange





## Environmental Goals

Our legacy of sustainability continues with our path to zero which is our commitment to continually reduce our environmental footprint. We believe in leadership by continuous improvement with an emphasis on human health and our environment.

- 90% diversion from landfill and carbon neutrality
- We're also a proud members of USGBC and LEED.
- Varia contains over 40% recycled material

Visit [3-form.com/align](https://3-form.com/align) to learn more.



3form has twelve electric vehicle charging stations and 100% electricity offset.



The background is an abstract composition of overlapping, semi-transparent green planes. These planes are oriented at various angles, creating a sense of depth and perspective. The colors range from a light, pale green to a deeper, more saturated teal. The overall effect is clean, modern, and architectural. In the lower right quadrant, the words "Reception Kiosks" are written in a large, bold, white sans-serif font. The text is centered horizontally within its area and stands out clearly against the green background.

# Reception Kiosks



## Geometric Lightbox Reception

Nothing carries light quite like Chroma. Leave a lasting impression with these beautifully illuminated reception desks. Choose your orientation and a color from our extensive color portfolio.

Visit [3-form.com](http://3-form.com) to see additional details.

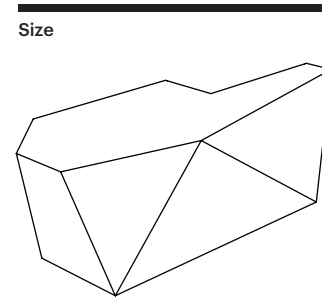

Left-side orientation  
70.22" W x 27" H x 28" D  
(1784mm x 686mm x 711mm)



Product | 600.19 Color | Jewel B11 + Powder



## Chroma Lightbox Reception

Created with light-loving Chroma, this five-sided lightbox takes the existing millwork of a reception desk to the next level. Comes in two sizes with proprietary lighting.

Visit [3-form.com](http://3-form.com) to see additional details.

### Available Sizes

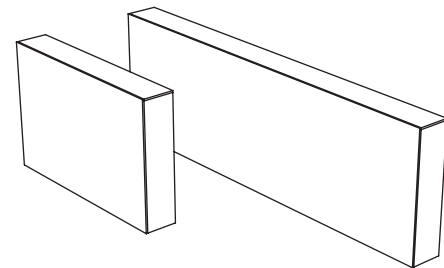

Small  
48" W x 31" H x 8" D  
(1220mm x 785mm x 205mm)

Large  
96" W x 31" H x 8" D  
(2440mm x 785mm x 205mm)







Product | 600.02 Color | Clementine O07 + Powder D03

## Wrapped Lightbox

Chroma is like jewelry for an interior. Add some bling and make your space glow with this beautiful wrapped corner reception desk.

Visit [3-form.com](http://3-form.com) to see additional details.

### Available Sizes

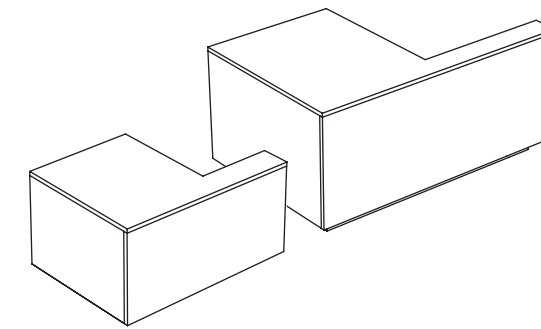

Small  
28" W x 42" L x 24" H  
(710mm x 1070mm x 610mm)

Large  
40" W x 64" L x 30" H  
(1015mm x 1625mm x 765mm)

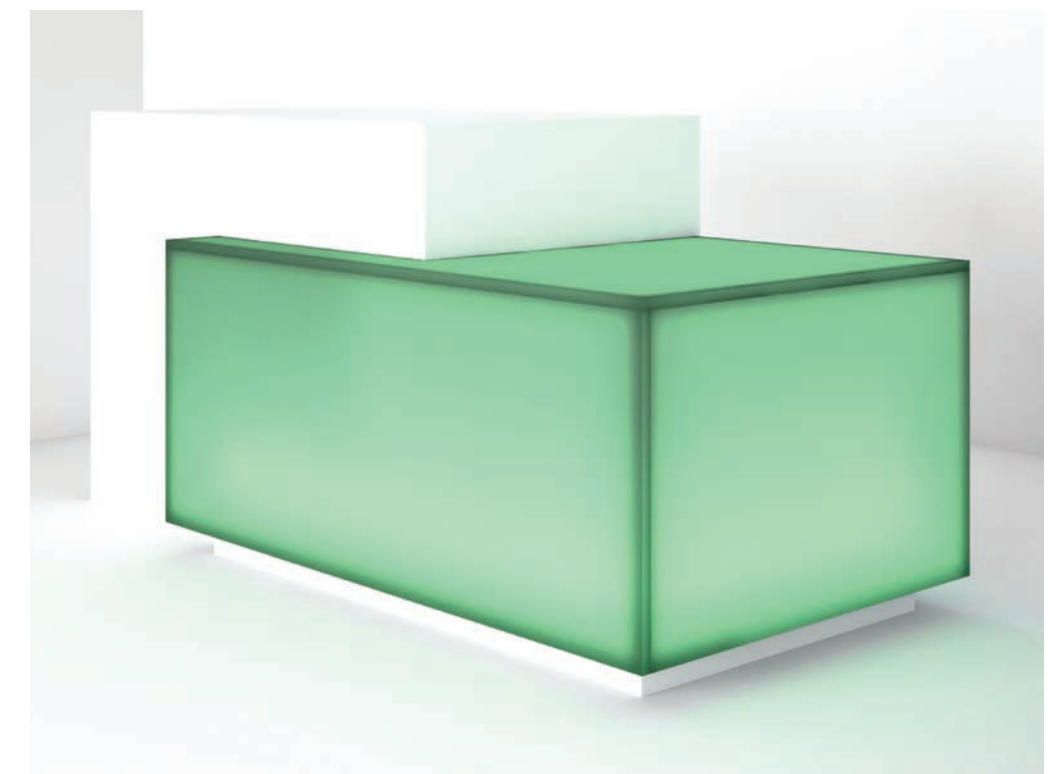

Product | 600.02 Color | Shamrock G47 + Powder D03



## Inverted Lightbox Reception

Sometimes doing the inverse is the way to go. Add a recessed lightbox to your reception desk with RGB lighting for a unique, dynamic statement.

Visit [3-form.com](http://3-form.com) to see additional details.

### Available Sizes

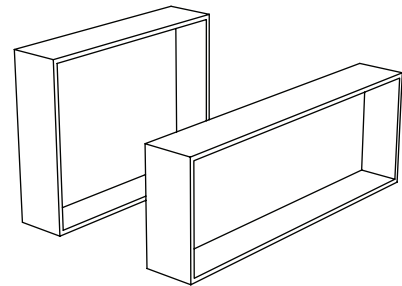

High 48" W × 38" H × 11.5" D (1219mm × 965mm × 292mm)	Low 72" W × 26" H × 11.5" D (1829mm × 660mm × 292mm)
---	--



Product | 600.18    Color | Glacier D05 + RGB Lighting



## Varia Reception

Expand the possibilities with  
Varia's extensive pattern library.

Visit [3-form.com](http://3-form.com) to see additional details.

### Available Sizes

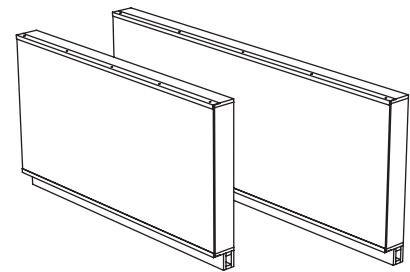

Small  
72" W x 36" H  
(1830mm x 915mm)

Large  
96" W x 36" H  
(2440mm x 915mm)



Product | 600.06    Pattern | Fray Smoke + Powder D03





## Profile Reception

Never underestimate the importance of texture when designing spaces. By simply incorporating a single Profile panel you can transform common areas.

Visit [3-form.com/profile](https://3-form.com/profile) to see all patterns and finishes.

See All Pattern Options on Page 142-143



Bub



Mingle



Metric



Veer



Nod



Chisel





A stack of books is on the left side of a wooden desk. A black, trapezoidal paperweight with a small circular hole is positioned on the desk. The background is a dark, textured wall. The text "Space Division" is overlaid in white on the right side of the image.

# Space Division





## Divide Partitions

Direct traffic, section off areas of focus, and cultivate collaboration with everything from walls and workstations to corners and zones. Available in ten standard configurations, Divide Partitions are as beautiful as they are functional.

Visit [3-form.com/elements](https://3-form.com/elements) to see additional details.



**Design Choices**  
Select a color and pattern of translucent Varia, and choose a hardware finish to bring it all together.



**Markerboards**  
Add glass markerboards to Divide Partitions to seamlessly integrate writable surfaces.



**Hush Bar**  
Reduce noise with NRC .80 sound dampening, tackable Hush Bars made from Sola Felt.



**Hush Mount**  
Easily and seamlessly mount various accessories, such as a TV or Markerboard.



**Shelving**  
Increase utility without overwhelming the space with integrated shelves.



**Coat Hook**  
Keep the space organized with hooks designed to blend in with the Divide Partitions aesthetic.





## Divide Partition 8' Wall

Separate a seating area or funnel foot traffic with this versatile partition wall.

Visit [3-form.com/elements/products/divide-partitions-walls](https://3-form.com/elements/products/divide-partitions-walls) to see additional details.

Size

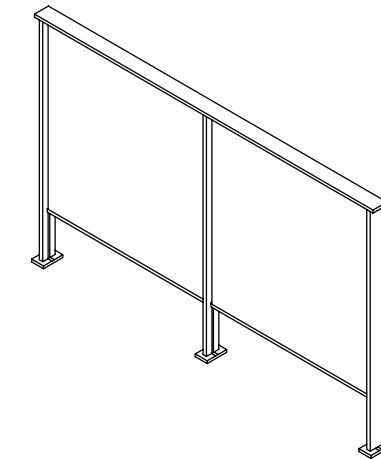

2 Panel Partition  
96" W x 60" H | 12" Reveal  
(2438mm x 1524mm | 305mm)



## Divide Partition 12' Wall

Separate a seating area or funnel foot traffic with this versatile partition wall.

Visit [3-form.com/elements/products/divide-partitions-walls](https://3-form.com/elements/products/divide-partitions-walls) to see additional details.

Size

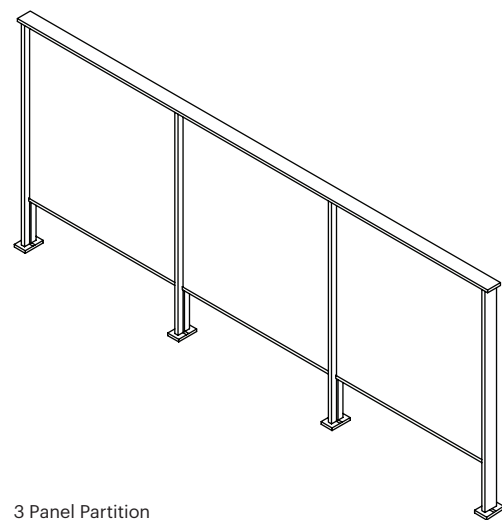

3 Panel Partition  
144" W × 60" H | 12" Reveal  
(3658mm × 1524mm | 305mm)



Product | 200.88 Color | Equinox Hardware | Taupe Gray Matte





## Divide Partition Workstations

Define individual workspaces for ultimate productivity with this versatile partition wall.

Visit [3-form.com/elements/products/divide-partitions-walls](https://3-form.com/elements/products/divide-partitions-walls) to see additional details.

Size

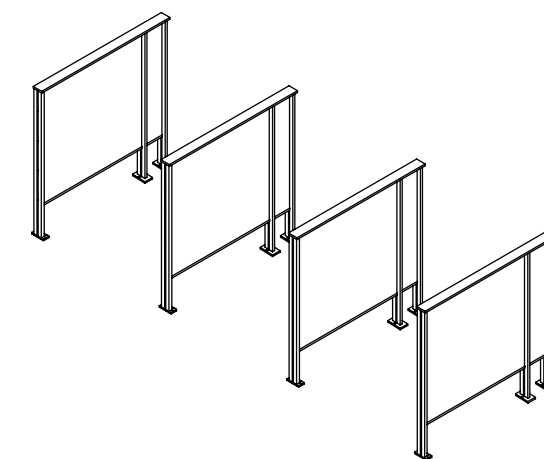

Individual Partitions  
60" W x 60" H | 12" Reveal  
(1524mm x 1524mm | 305mm)

Product | 200.96 Color | Deep Ocean Hardware | Slate Gray Matte



## Divide Partition 5' x 5' Corner

Create a seating nook with  
this versatile partition corner.

Visit [3-form.com/elements/products/divide-partitions-corners](https://3-form.com/elements/products/divide-partitions-corners)  
to see additional details.

Size

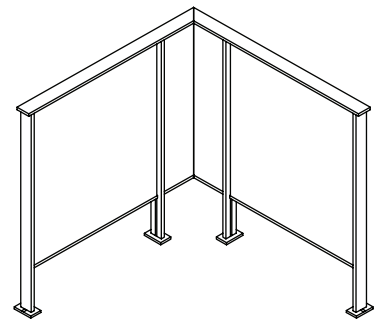

2 Panel Corner  
60" W x 60" H x 60" D | 12" Reveal  
(1524mm x 1524mm x 1524mm | 305mm)



Product | 200.90 Color | Bask Hardware | Shadow Gray Matte



## Divide Partition 9' x 5' Corner

Create a seating nook for two  
with this versatile partition corner.

Visit [3-form.com/elements/products/divide-partitions-corners](https://3-form.com/elements/products/divide-partitions-corners)  
to see additional details.

Size

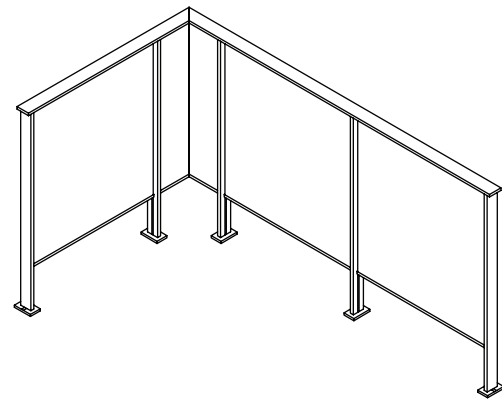

3 Panel Corner  
108" W x 60" H x 60" D | 12" Reveal  
(2743mm x 1524mm x 1524mm | 305mm)



Product | 200.93 Color | Umbra Hardware | Pebble Gray Matte



## Divide Partition 9' x 9' Corner

Provide privacy and define a meeting area with this versatile partition corner.

Visit [3-form.com/elements/products/divide-partitions-corners](https://3-form.com/elements/products/divide-partitions-corners) to see additional details.

Size

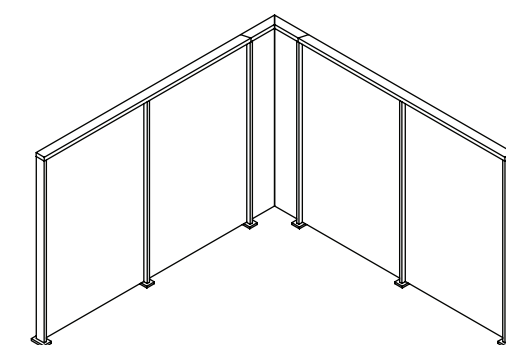

4 Panel Corner  
108" W x 72" H x 108" D  
(2743mm x 1524mm x 2743mm)



Product | 200.97    Color | Prose    Hardware | Bone Gray Matte





## Divide Partition Flex

Create dynamic and versatile work zones with this sleek partition.

Visit [3-form.com/elements/products/divide-partitions-zones](https://3-form.com/elements/products/divide-partitions-zones) to see additional details.

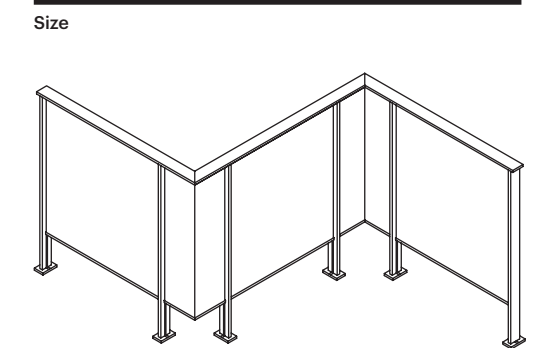

3 Panel Zone  
120" W x 60" H x 72" D | 12" Reveal  
(2743mm x 1524mm x 1829mm | 305mm)



## Divide Partition Merge

Balance collaboration & seating areas with this versatile partition.

Visit [3-form.com/elements/products/divide-partitions-zones](https://3-form.com/elements/products/divide-partitions-zones) to see additional details.

Size

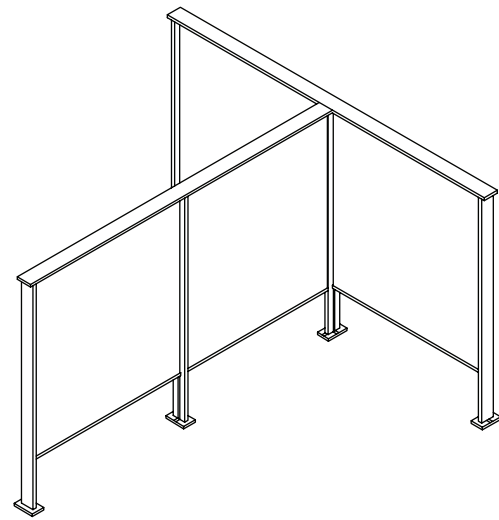

4 Panel Zone  
96" W x 60" H x 96" D | 12" Reveal  
(2438mm x 1524mm x 2438mm | 305mm)



Product | 200.95    Color | Orbit    Hardware | Pebble Gray Matte



## Divide Partition 6' Bay

Provide privacy for an individual area of focus or a seating nook with this translucent partition.

Visit [3-form.com/elements/products/divide-partitions-zones](https://3-form.com/elements/products/divide-partitions-zones) to see additional details.

Size

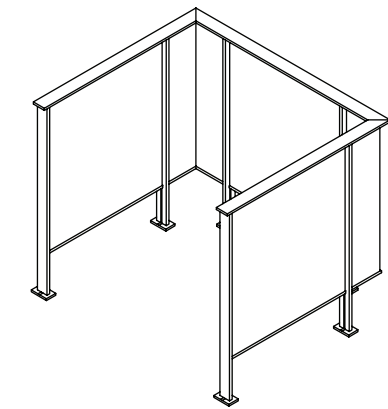

3 Panel Zone  
72" W x 60" H x 60" D | 12" Reveal  
(2438mm x 1524mm x 1524mm | 305mm)



Product | 200.91    Color | Cinema    Hardware | Shadow Gray Matte



## Divide Partition 10' Bay

Create a space for one-on-one conversations or a shared seating area with this translucent partition.

Visit [3-form.com/elements/products/divide-partitions-zones](https://3-form.com/elements/products/divide-partitions-zones) to see additional details.

Size

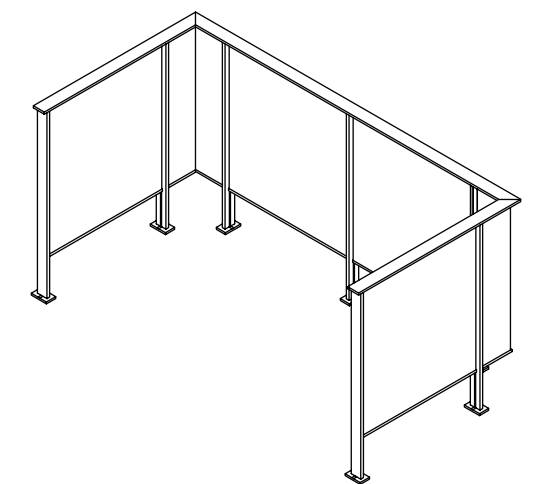

4 Panel Zone  
120" W × 60" H × 60" D | 12" Reveal  
(3048mm × 1524mm × 1524mm | 305mm)



Product | 200.94 Color | Basalt Hardware | Pebble Gray Matte



## Desk Partitions

Desk Partitions integrate seamlessly into existing office layouts to divide personal workspaces with multiple configurations and non-damaging hardware. Available in a select range of Varia design options or acoustical Sola Felt.

 **Durable**

 **Sustainable**

 **Fire Safe**

Visit [3-form.com/products/desk-wrap-partition](https://3-form.com/products/desk-wrap-partition) to see additional details.



Material | Varia Pattern | Mesh Tetons



Material | Varia Pattern | Hem Abbot Configuration | L Right Hardware | Black





Material | Sola Felt Color | Cast Configuration | U Hardware | Black



Material | PETG Gloss Configuration | U Hardware | Black





Product | 200.48 Pattern | Tilt Color | Admiral

## Seeyond Acoustic Partitions

Create a private space, contain sound, and build a more cozy environment with this modular tile system.

 NRC 1.10 |  SAA 1.08 |  a<sup>w</sup> 1.0

Visit [3-form.com/seeyond](https://3-form.com/seeyond) to see additional details.

### Pattern Options

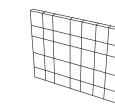

Court

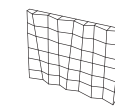

Tilt



Cusp

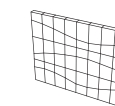

Billow

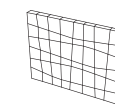

Kink



Product | 200.48 Pattern | Cusp Color | Cast





## Seeyond Acoustic Curved Partitions

Seeyond is a sound absorbing, curved partition that is made from 50% recycled PET.

 **NRC 1.10** | **SAA 1.08** | **a<sup>w</sup> 1.0**

See page 140 for all Sola Felt colors.

### Pattern Options

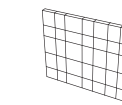

Court

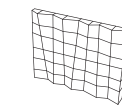

Tilt



Cusp

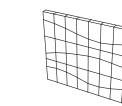

Billow

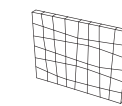

Kink

Product | 200.49   Pattern | Court   Color | Driftwood



Pattern | Veil Coastline Hardware | Stainless Steel



## Dello Partitions

Go frameless and divide space with Dello suspended partitions. With Varia you can add color and patterns or graphics to bring your vision to life.

Visit [3-form.com](http://3-form.com) to see all our interlayers.

### Suspended Configuration

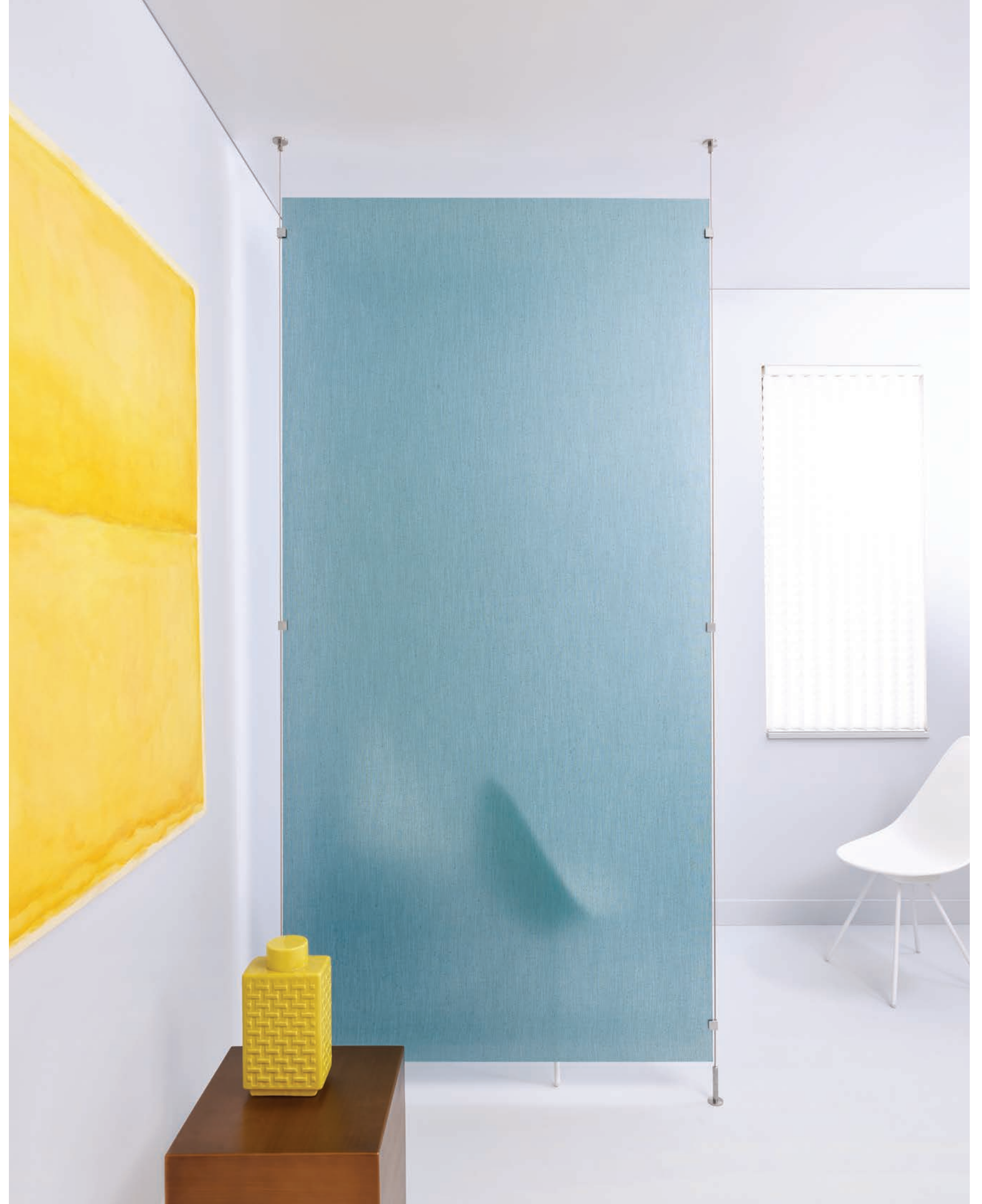
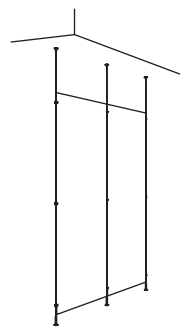





## Divy Acoustic Partitions

Transform vertical space with acoustic panels highlighted by geometric patterns. Divy partitions and baffles absorb sound and double as tackable surfaces.

 **NRC .75** | **SAA .76** | **a<sup>w</sup> .70<sup>(H)</sup>**

Visit [3-form.com/divy](https://3-form.com/divy) to see hardware finishes.

### Pattern Options

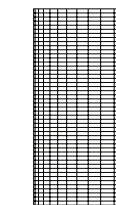

Accord



Margin

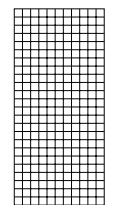

Net

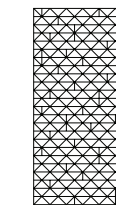

Quint



Vim

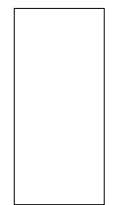

Plane



## Edge Suspended Partitions

Repeating fins of Varia or Sola Felt come together to create space dividers that evoke movement, rhythm, and sophistication.

 **NRC** .55 | **SAA** .57 | **a<sup>w</sup>** .45  
\*When specified with Sola Felt

Visit [3-form.com/edge](https://3-form.com/edge) to see more options.

### Pattern Options



Uniform

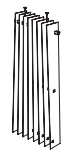

Fan



Stepped



Contour



Jagged

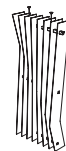

Diagonal



Arc



Hourglass



Angle







Product | 200.42    Pattern | Tribe Sunset, White Out W01 + Writeable F18

## Freestanding Moveable Partition

A single Varia panel mounted on wheels lets you create a moveable feast of design. Removable casters and freestanding feet eliminate the need for anchoring.

Visit [3-form.com/products/freestanding-moveable-partition](https://3-form.com/products/freestanding-moveable-partition) to learn more.



# Acoustic Solutions





## Acoustic Solutions

3form offers a complete range of acoustical solutions, but more importantly, we provide the knowledge and expertise to make your project a success.

Visit [3-form.com/acoustics](https://3-form.com/acoustics) to see all solutions.

### Ceiling Solutions Pg

1 Tetria   NRC 0.85	90
2 Clario Cloud   NRC 0.75	88
3 Clario Baffles   NRC 0.70	86
4 Edge Ceiling   NRC 0.55	104
5 Seeyond Ceiling   NRC 1.10	82
6 Velo   NRC 0.85	92
7 Divy Baffles   NRC 0.75	72

### Wall Solutions Pg

8 Edge Wall   NRC 0.55	102
9 Seeyond Wall   NRC 1.10	80
10 Hush Blocks   NRC 0.80	76
11 Hush Clad   NRC 0.35	78

### Partitions Pg

12 Edge Partition   NRC 0.55	64
13 Seeyond Partition   NRC 1.10	56
14 Divy Mobile   NRC 0.75	74
15 Divy Partition   NRC 0.75	62





Product | 400.46 Pattern | Vim Color | Dune

## Divy Acoustic Baffles

A subtle pattern, birch frame, and sleek hardware are ready for your own design contribution. Divy Baffles are easy-to-install, NRC rated, and Class A fire rated.

 **NRC .75** | **SAA .76** | **a<sup>w</sup> .70<sup>(H)</sup>**

Visit [3-form.com/divy](https://3-form.com/divy) for hardware finishes.

### Pattern Options



Plane



Accord



Margin



Net



Vim

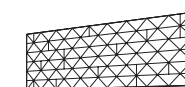

Quint



## Divy Mobile Acoustic Panels

Divy Mobile is an acoustic partition and tack wall in a lightweight, movable package. Available with casters or sliders.

 NRC .75 | SAA .76 | a<sup>w</sup> .70 (H)

See page 140 for all Sola Felt colors.

### Pattern Options

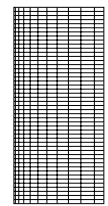

Accord



Margin

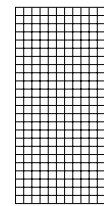

Net

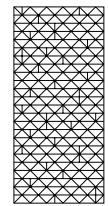

Quint



Vim

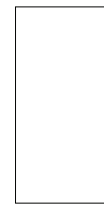

Plane



Product | 200.63 Pattern | Margin Color | Nickel





Product | 300.43 Colors | Emerald, Ebony, Armor, Nickel

Product | 300.43 Colors | Armor, Dusk, Admiral



## Hush Blocks

3form Hush Blocks are an excellent way to add color, texture, and sound absorption to any space. You can choose from 6 shapes and 15 colors plus they're a cinch to arrange and install.

 **NRC .80 | SAA .79 | a<sup>w</sup> .65**

Visit [3-form.com/hushblocks](https://3-form.com/hushblocks) to see additional options.

### Hush Blocks Shapes

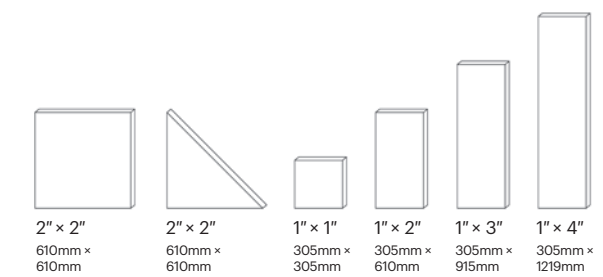



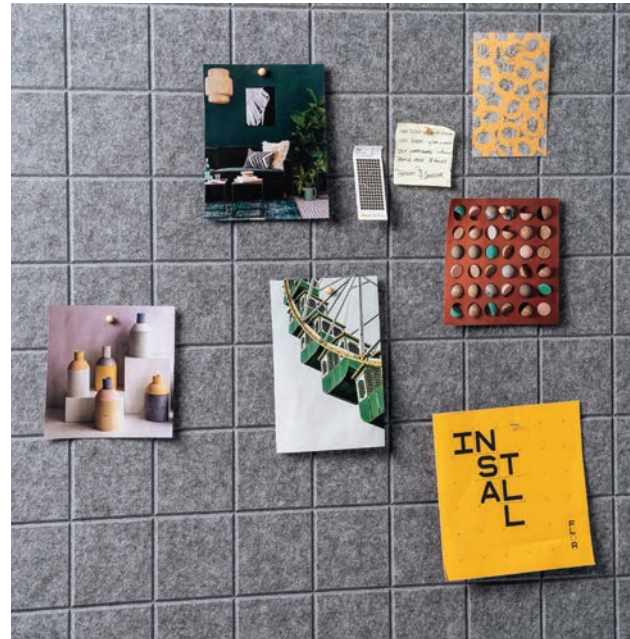

## Hush Clad

Choose a pattern style, and one of 15 colors to quiet your space, while turning up the cool factor.

 NRC .35 | SAA .35 | a<sup>w</sup> .25 (H)

See page 140 for all Sola Felt colors.

### Pattern Options

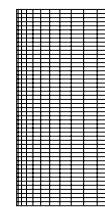

Accord

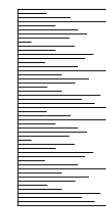

Margin

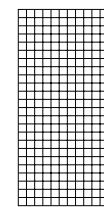

Net

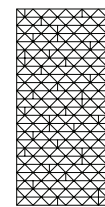

Quint

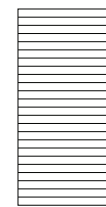

Vim

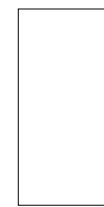

Plane







Product | 300.42 Pattern | Tilt Color | Nickel

## Seeyond Wall

Unique, sound absorbing wall solution that is easy to install.

 NRC 1.10 | SAA 1.09 | a<sup>w</sup> 1.0

Visit [3-form.com/seeyond](https://3-form.com/seeyond) for more options.

### Pattern Options

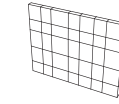

Court

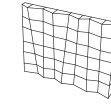

Tilt



Cusp

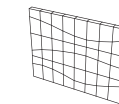

Billow

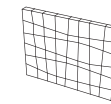

Kink



Product | 300.42 Pattern | Cusp Color | Cast





## Seeyond Ceiling

Seeyond decreases reverberation and dampens sound energy. This textured solution is ideal for loud open conference spaces.

 NRC 1.10 | SAA 1.09 | a<sup>w</sup> 1.0

Visit [3-form.com/seeyond](https://3-form.com/seeyond) to see more options.

### Pattern Options

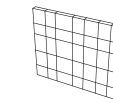

Court

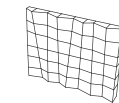

Tilt

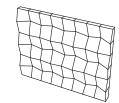

Cusp

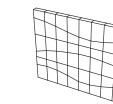

Billow

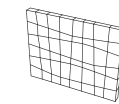

Kink

Product | 400.42 Pattern | Billow Color | Nickel



## Seeyond Wall-to-Ceiling

Create unique space solutions with our NRC and Class A fire rated acoustic felt that's made with PET.

 NRC 1.10 | SAA 1.09 | a<sup>w</sup> 1.0

Visit [3-form.com/seeyond](https://3-form.com/seeyond) to see more options.

### Pattern Options

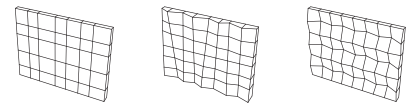

Court

Tilt

Cusp

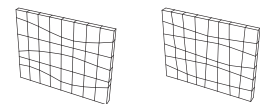

Billow

Kink



Product | 350.07 | Pattern | Tilt | Color | Cast





Product | 400.44 Color | Zinc

## Clario Ceiling Tile

Visually-stunning, highly-functional Sola Felt ceiling baffle. This product is easy-to-install, and comes in two sizes you can use to fill any ceiling.

 NRC .70 | SAA .69 | a<sup>w</sup> .65 (+)

### Sizes

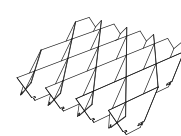

24" x 24"

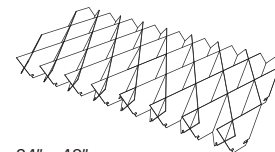

24" x 48"

Visit [3-form.com/clario](https://3-form.com/clario) to see additional details.





## Clario Cloud

Suspended, NRC-rated Clario ceiling baffles feature tapered edges for a refined look. Available as standalone circles or in modular square configurations.

 NRC .75 | SAA .77 | a<sup>w</sup> .70 (MH)

Visit [3-form.com/clario](https://3-form.com/clario) to see additional details.

### Square Size

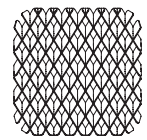

48" x 48"  
(1219mm x 1219mm)

### Circle Sizes

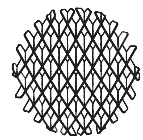

48" x 48"  
(1219mm x 1219mm)

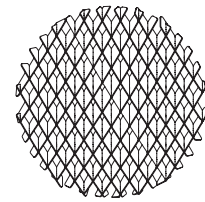

72" x 72"  
(1829mm x 1829mm)







Product | 400.45 Color | Cast Tile | 01

## Tetria

Acoustic square tiles you can add to your drop-ceiling grid to transform a basic ceiling into a sculptural landscape of shape and color.

 NRC .90 | SAA .89 | a<sup>w</sup> .90

Visit [3-form.com/tetria](https://3-form.com/tetria) to see more details.

### Shape Options

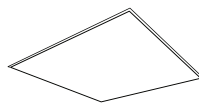
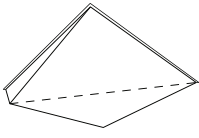
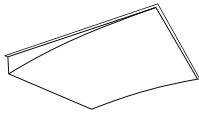
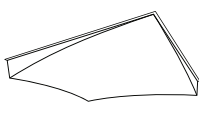
- 00 
- 01 
- 02 
- 03 



## Velo

Turn your overhead space into a work of art with Velo, a suspended ceiling system made up of Velo acoustic tiles.

 **NRC .85** | **SAA .84** | **a<sup>w</sup> .85**

Visit [3-form.com/velo](https://3-form.com/velo) to see color options.

### Shape Options

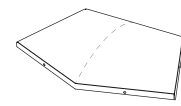

Concave

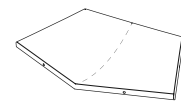

Convex



Product | 400.43 Colors | Citrine, Zinc



A white plastic chair with a wooden seat is positioned on the left side of the frame. The background is a wall with a dark wood-grain pattern. The text "Wall & Ceiling Solutions" is overlaid on the right side of the image in a large, white, sans-serif font.

# Wall & Ceiling Solutions





## Profile Wall Panels

Sophisticated and unique patterns bring impact to spaces with dramatic texture and color.

Visit [3-form.com/profile](https://3-form.com/profile) to see additional details.

See All Pattern Options on Page 142-143

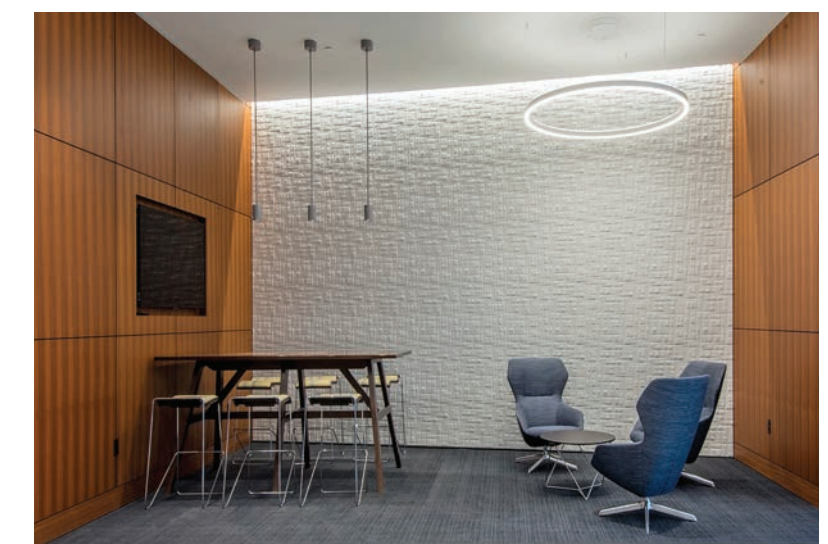
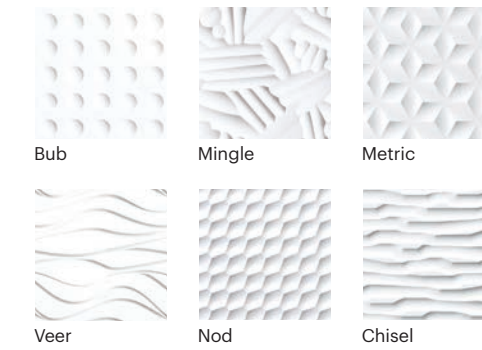

Product | 300.35 Pattern | Metro Color | Crystal White





## Profile Tiles

Modular tiles transform walls with striking three-dimensional patterns.

Visit [3-form.com/products/profile-tiles](https://3-form.com/products/profile-tiles) to see additional details.

### Tile Pattern Options



Flank



Subway



Quarry



Verve



Glide



Swoon







Product | 300.35 Pattern | Burst Color | Crystal White

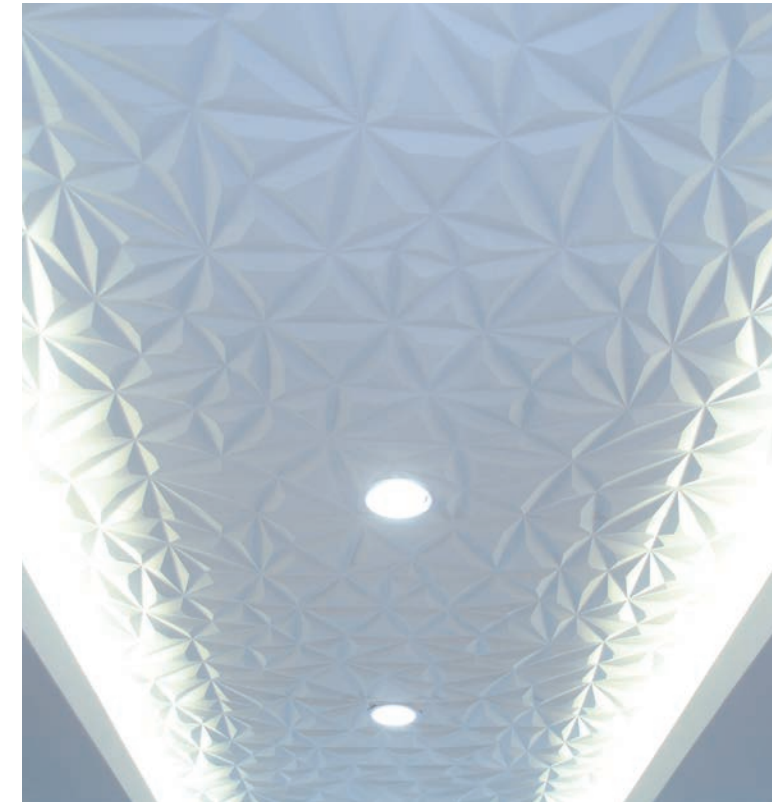

## Profile Ceiling Panels

Specify Profile panels on the ceiling to create a textural feature that gives people a reason to look up.

Visit [3-form.com/profile](https://3-form.com/profile) to see additional details.

See All Pattern Options on Page 142-143

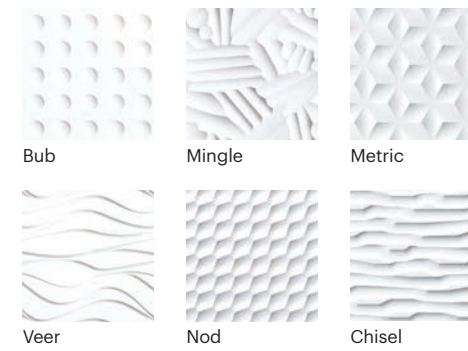



## Edge Wall Solution

Use Varia or Sola Felt repeating louvers to create visual impact, reduce sound, and accent space in a beautiful way.

 **NRC .45** | **SAA .57** | **a<sup>w</sup> .45**  
\*When specified with Sola Felt

Visit [3-form.com/edge](https://3-form.com/edge) to see more options.

### Pattern Options

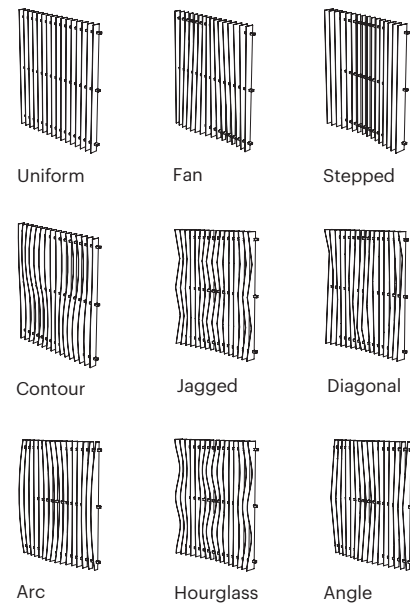

Product | 300.31    Pattern | Contour    Color | Hyacinth B59, Tahoe B53, Pier B45





## Edge Ceiling Solution

Repeating ceiling fins form a visually compelling ceiling feature you can take to the next level with your creative input.

 **NRC** .45 | **SAA** .57 | **a<sup>w</sup>** .45  
\*When specified with Sola Felt

Visit [3-form.com/edge](http://3-form.com/edge) to see more options.

### Pattern Options

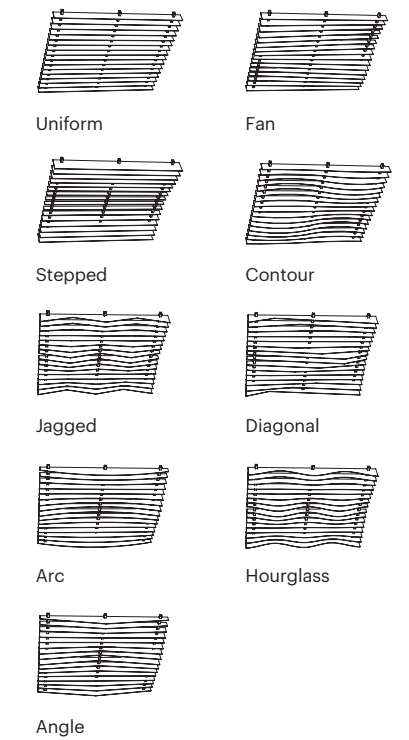

Product | 400.37    Pattern | Arc    Color | Flood B44 + Surf B38





# Tabletops



## Chroma Tabletops

Beautiful, high-quality materials  
and distinguishing features that  
set your horizontal surfaces apart.

*Visit [3-form/chroma](#) for more details.*



Product | Custom Table Color | Wizard B30 + Reflect





## Chroma Countertops

Chroma withstands the demands of countertops like a champ.

Visit [3-form.com/chroma](https://3-form.com/chroma) for more details.

Product | 600.17 Color | Punch O21 + RGB Lighting





# Marker-boards





Product	Pattern	Color
200.65	Net	Cast
200.63	Vim	Citrine
200.64	Quint	Ruby

## Divy Mobile

Divy Mobile is an acoustic partition and tack-wall in a single, lightweight, movable package.

See page 140 for all Sola Felt colors.





## Mobi

Mobi is a free-standing, two-sided mobile magnetic Glass Markerboard featuring a modern design, minimal frame, and smooth, quiet casters.

*Visit [3-form.com](http://3-form.com) for more information.*

### Dimensions

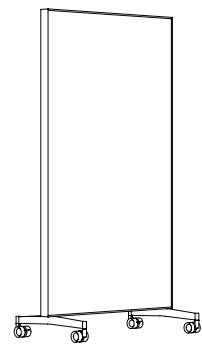

39.4" W × 73.8 H × 22.5" D  
(1000mm × 1875mm × 572mm)



## Glass Markerboards

Add function to your workspace with a single panel of magnetic, glass markerboard that you can customize to your needs.

See page 144 for colors and finishes.

### Aluminum Frame Options



Floating

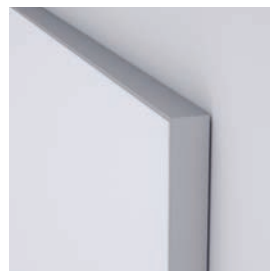

Framed





## Continuous Markerboards

Need a bigger canvas? Just add a panel to create a magnetic glass markerboard for spaces as wide as you can fill.

See page 144 for colors and finishes.

Aluminum Frame Detail



Continuous







Product | 300.45 Color | Glossy, Chalk Pattern | Dotted Line

## Functional Markerboard Patterns

Keep writing, diagrams, and schedules organized with subtle patterns created for corporate, healthcare, and higher education spaces.

### Patterns



Dot Grid



Plus Grid



Dotted Line



Solid Line Grid

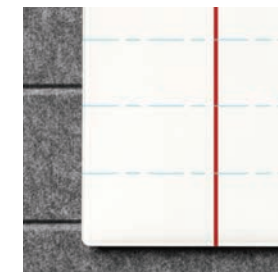

Old School







Product | 300.45 Color | Glossy, Chalk Softened Imagery | IM10646



## Softened Imagery

Digital printed imagery with a softened effect maintains legibility and serves as an art feature when markerboards are not in use. Select from our library of 1900+ licensed images, or customize with a logo.

Visit [3-form.com/image-gallery-portfolio](https://3-form.com/image-gallery-portfolio) for image options



## Markerboard Accessories

Add a Magnetic Markerboard Kit which includes an eraser, eight magnets, and a marker holder, an aluminum Magnetic Markerboard Tray, or a larger Accessory Shelf to keep items organized.

Visit [3-form.com](http://3-form.com) for more details.



Product | Magnetic Markerboard Tray    Finish | Anodized Aluminum



Product | Accessory Shelf    Finish | Anodized Aluminum



Product | Magnetic Markerboard Kit    Varia | Writeable





# Design Choices



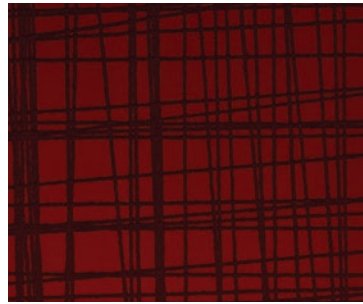

Ting Ting Carmine

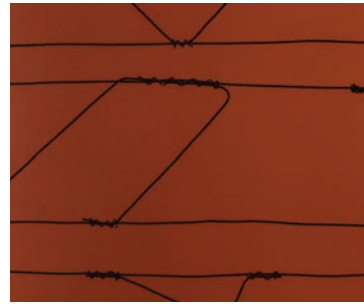

Ladder Mantle

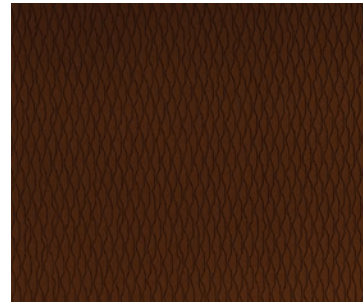

Scribble Cloud Kona



Mirage Iced Mint



Bentuk Pistachio

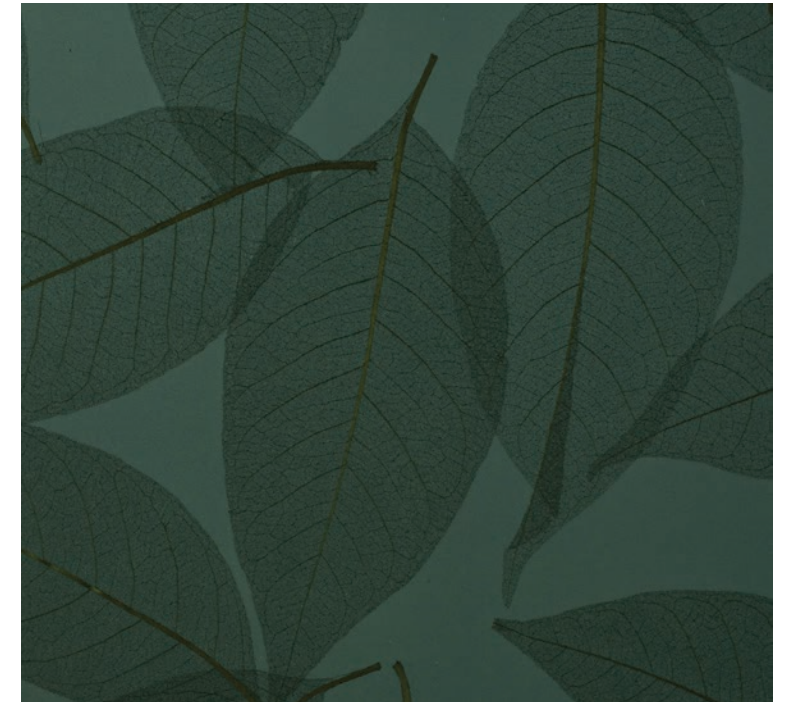

Fossil Leaf Iceberg

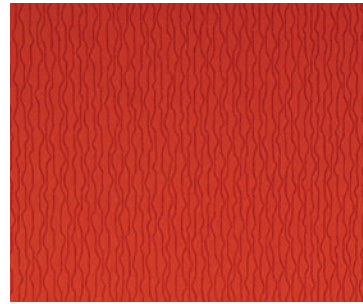

Scribble Cloud Blood Orange

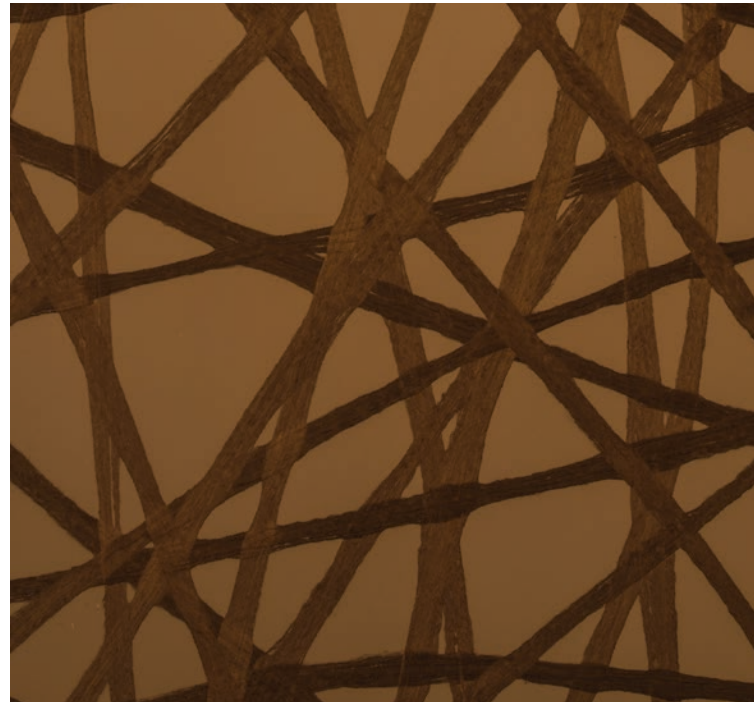

Connection Jetty

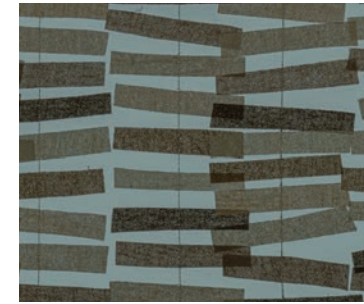

Tribe Sage

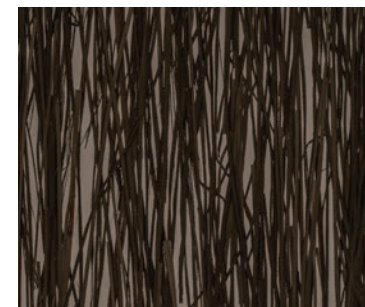

Bear Grass Avenue



Ladder Neptune

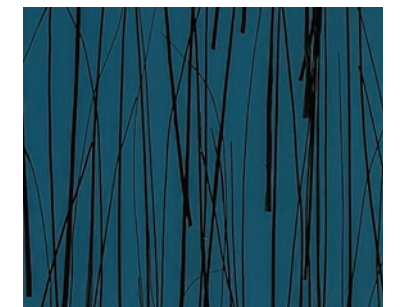

Ting Ting Laguna

## Design Collection

Our in-house design team explored the potential of Varia to create this new perspective on color & pattern in harmony.

Visit [3-form.com/samples](https://3-form.com/samples) for more options.



Slant Mulberry

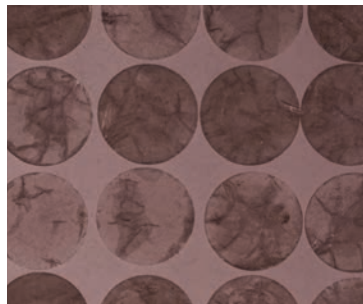

Capiz Reflection

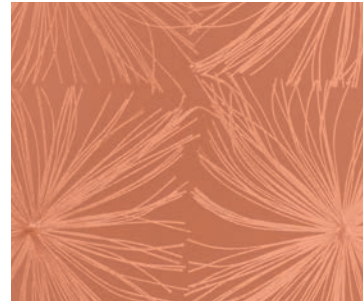

Savu Adobe



Coconut Husk Coastline



Struck Polar Sky



Savu Honeysuckle



Dance Chamomile

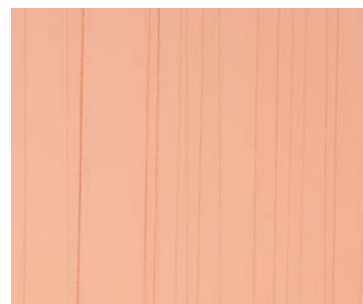

Mirage Sorbet



Tribe Crater





Flek Jetty

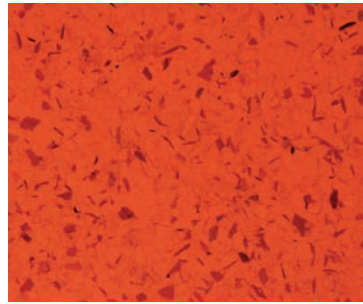

Flek Blood Orange

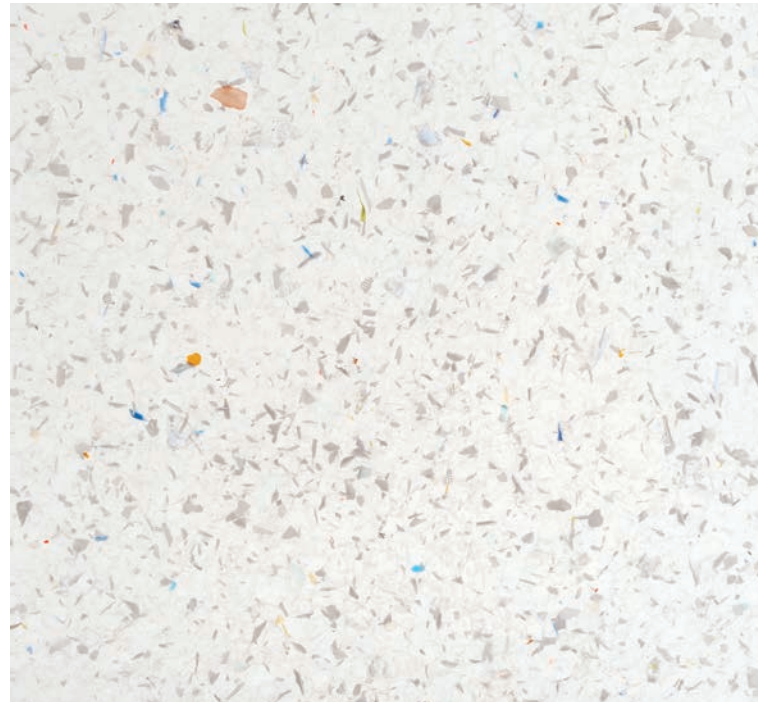

Flek Pure



Flek Avenue



Flek Chamomile

## Flek

More than ten years of R&D has resulted in these closed-loop panels made with ~75% recycled content.

Visit [3-form.com/samples](https://3-form.com/samples) for more options.



Flek Iced Mint



Flek Polar Sky



Flek Arctic Blue

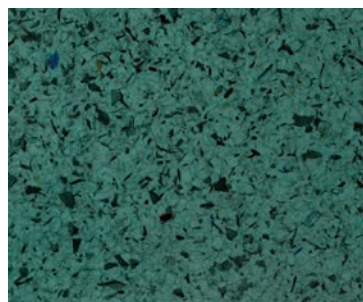

Flek Iceberg

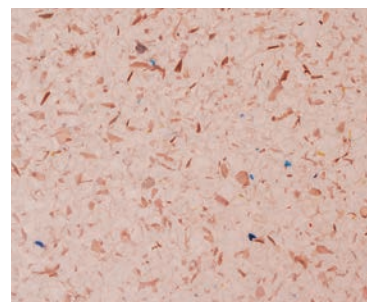

Flek Frosty Pink



Veil Comet



Veil Sage



Veil Neptune



Veil Honeysuckle



Veil Pistachio

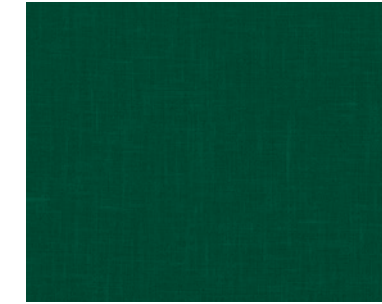

Veil Pine

## Veil

This subtly slubbed textile elegantly diffuses light. Signature colors enhance Veil's richness and depth.

Visit [3-form.com/samples](https://3-form.com/samples) for more options.



Veil Crater



Veil Coastline



Veil Blood Orange

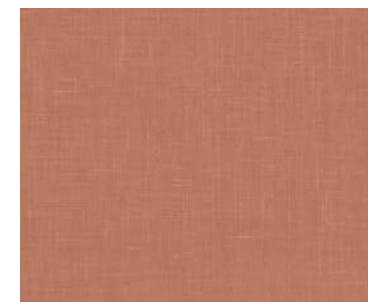

Veil Adobe

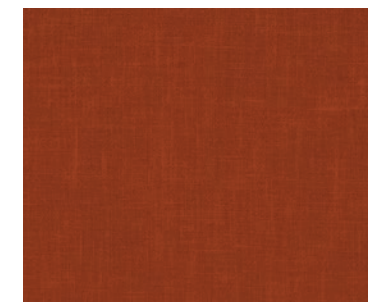

Veil Mantle



Veil Pure



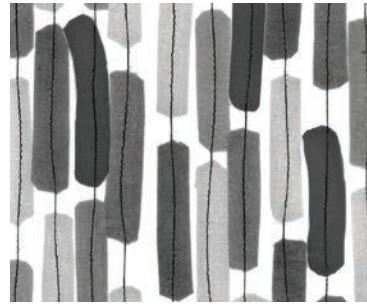

Ensign Gray

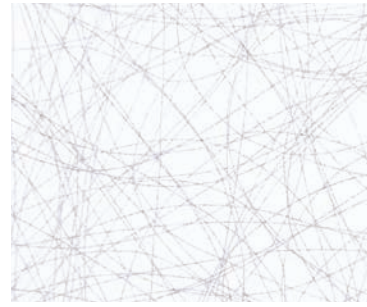

Wisp Silver

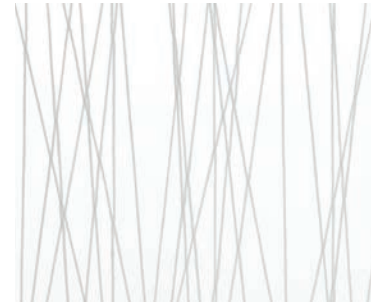

Slant Pure



Wenge



Fray Pearl



Fray Smoke



Fray Baltic

## Artisan

This exceptional collection celebrates the human desire to create from what's around us.

Visit [3-form.com/samples](https://3-form.com/samples) for more options.

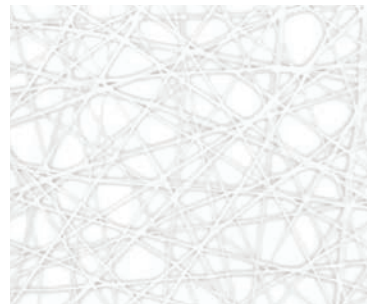

Connection Mini Pure



Connection Pure

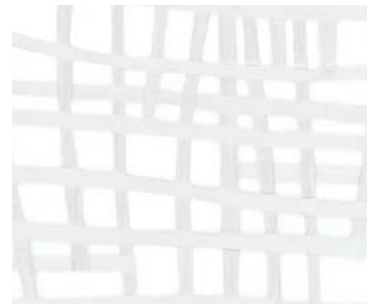

Connection Square Pure

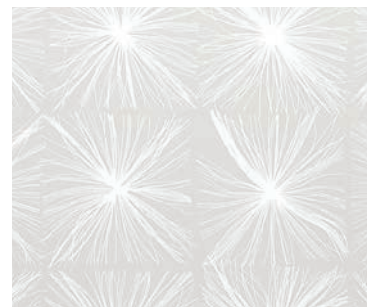

Savu Jasmine

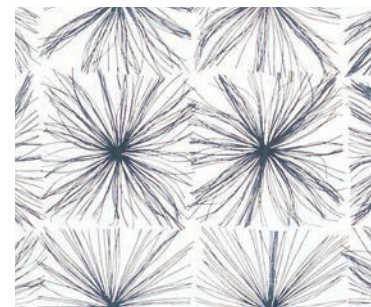

Savu Offshore

## Woods

From rich dark tones to modern light gray, the warm nature of wood inspires this collection.

Visit [3-form.com/samples](https://3-form.com/samples) for more options.



Cherry

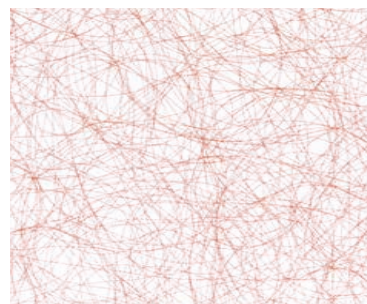

Wisp Copper

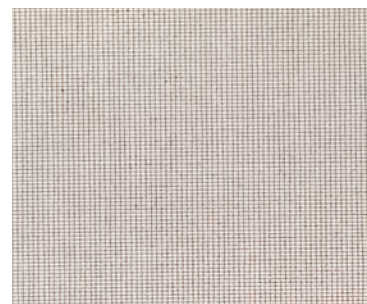

Bronze Weave

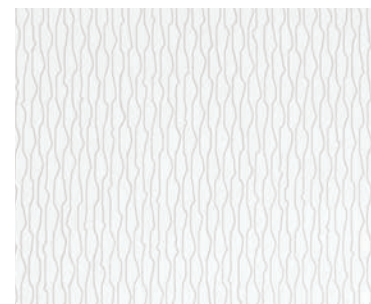

Scribble Cloud

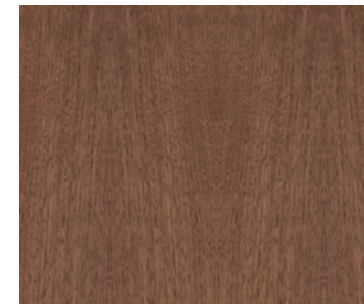

Walnut

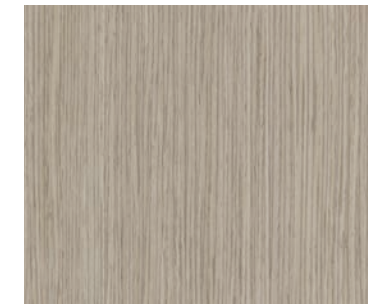

Gray Oak

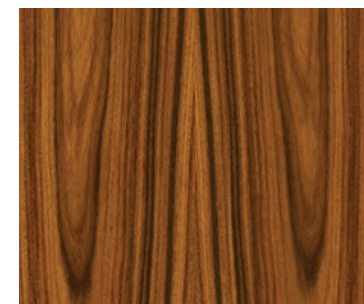

Rosewood





Hem Chiffon



Hem Tetons



Hem Ashland



Strand White



Strand Iron



Strand Lake

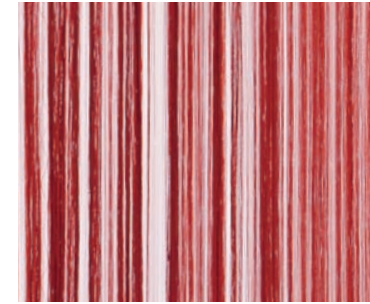

Strand Brick

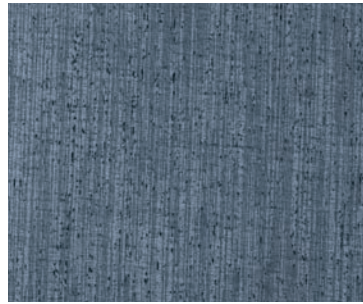

Hem Thames



Hem Celtic

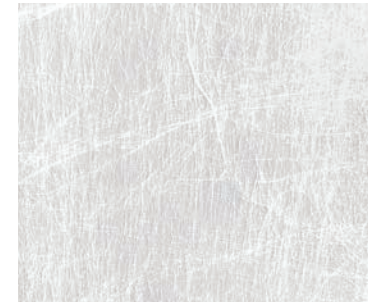

Spider



Linea Azure



Linea Ivory

## Textiles

A fascinating range of patterns and colors that completely rethinks the decorative aspects of fabric.

Visit [3-form.com/samples](http://3-form.com/samples) for more options.

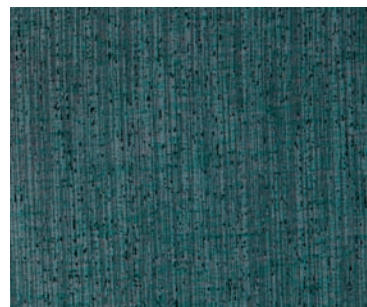

Hem Paine

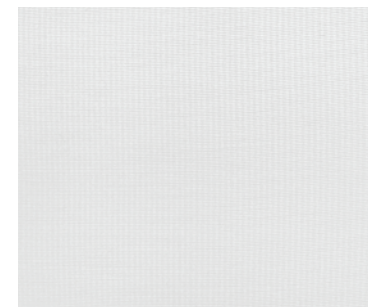

Mesh Chiffon



Mesh Tetons



Mesh Thames



Mesh Ashland



Hem Adore



Hem Shiraz



Hem Powell



Mesh Adore



Mesh Shiraz



Mesh Powell



Mesh Abbot



Hem Abbot



Mesh Azure

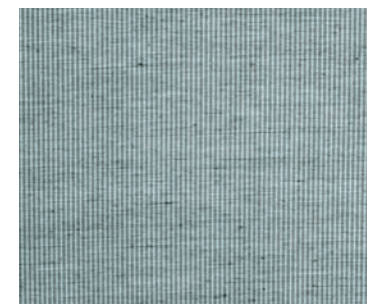

Mesh Paine



Mesh Celtic





Fossil Leaf Random

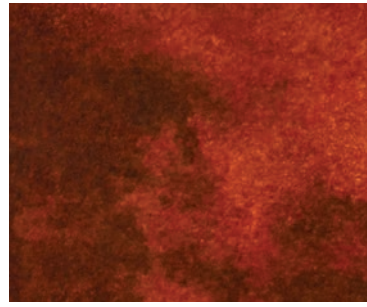

Forge

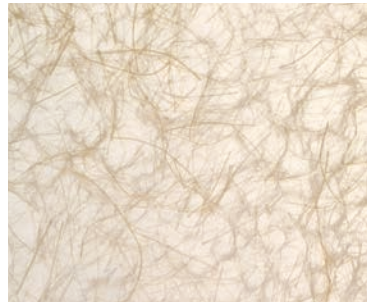

Mari Seamless

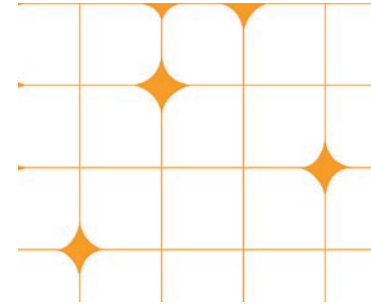

Cloy

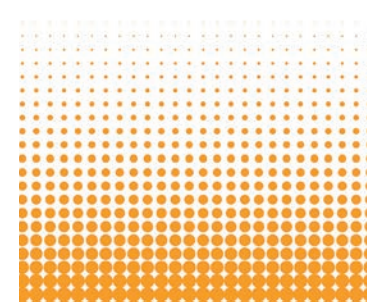

Halftone

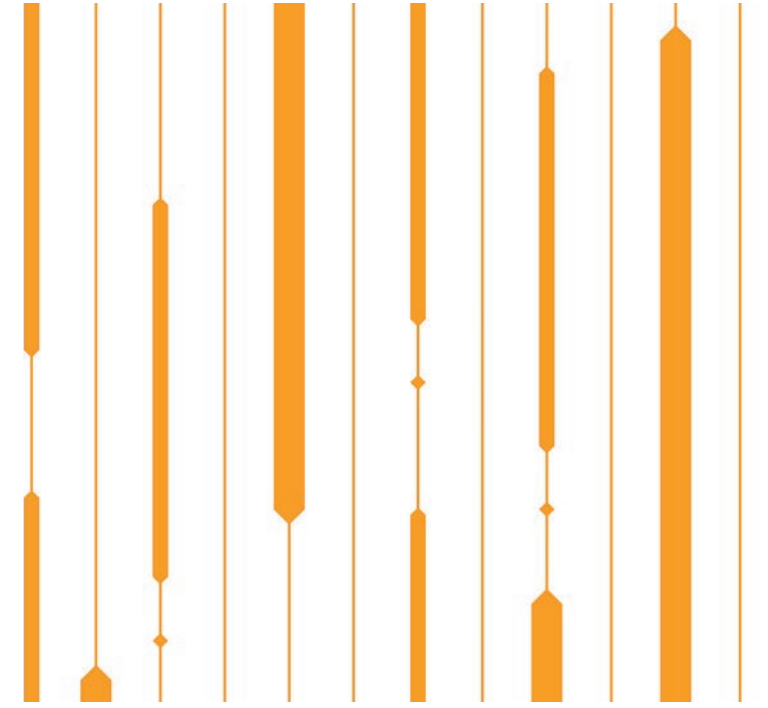

Belt



Ting Ting



Ginkgo Thatch

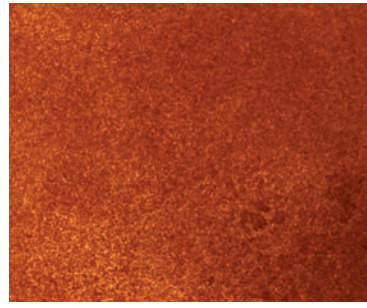

Oxide



Rice Grass

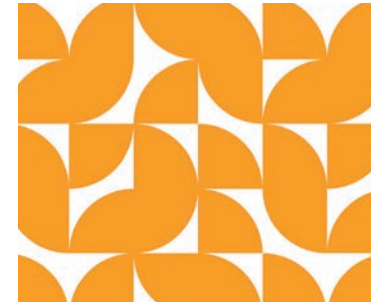

Sector

## Naturals

Reconnect with nature and create an awe-inspiring environment with our beautiful biophilic interlayers.

Visit [3-form.com/samples](https://3-form.com/samples) for more options.



Seaweed



Whisper

## Graphic Patterns

A design system of possibilities that allow you to create infinite combinations of color, opacity, scale, and more.

Visit [3-form.com/graphic-patterns](https://3-form.com/graphic-patterns) for more options.



Crossed Inverse

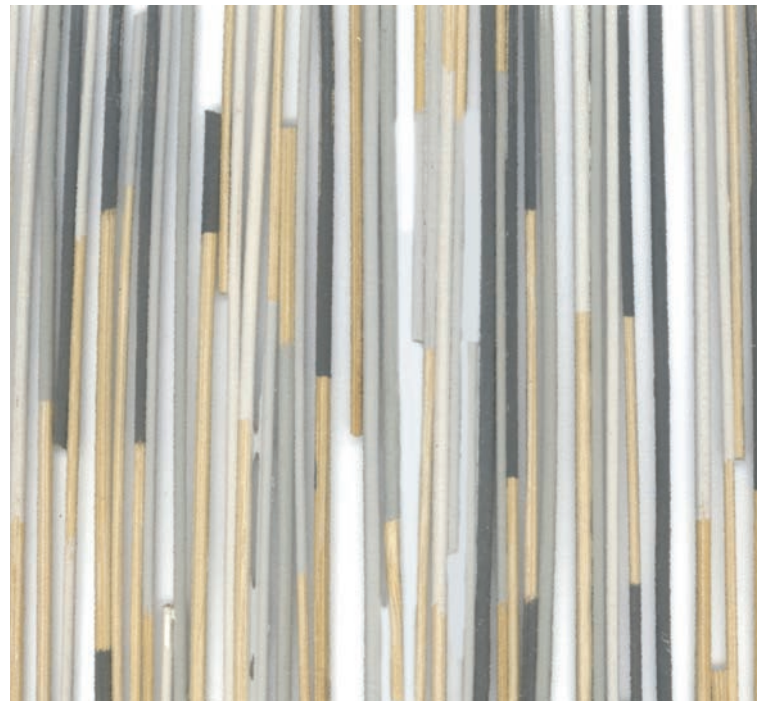

Lina Grays

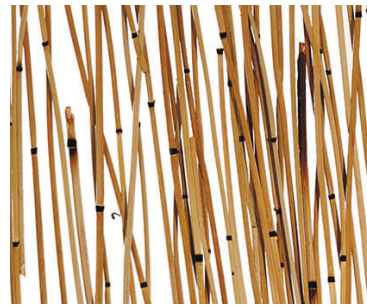

Thatch



Bear Grass



Bamboo Rings Dark



Kite

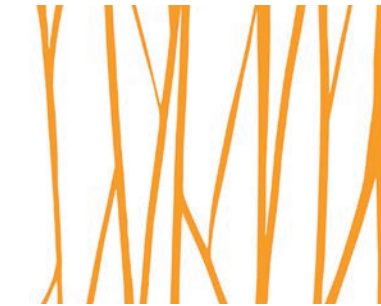

Branch



Retreat Inverse



# Varia & Chroma Colors

The 3form Color Portfolio offers the most comprehensive assortment of translucent colors for design. Each color can be combined with our diffusions to create a distinct look.

Visit [3-form.com](http://3-form.com) for more details.

## Diffusion/ Translucency



Avalanche 1%



Powder 45%



Vapor 65%

## Reflect



E01  
(only available on  
Chroma Tables)

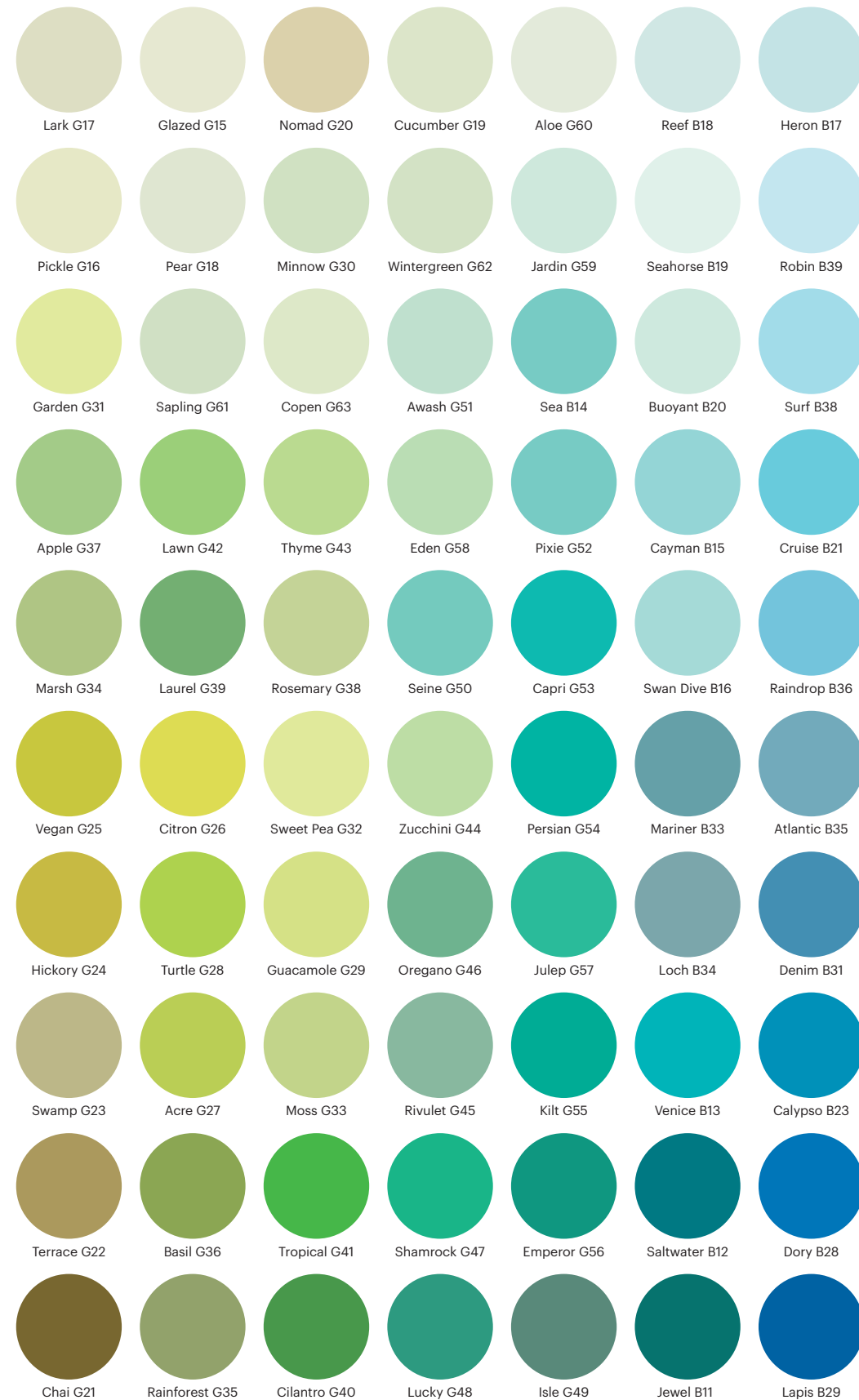





## Whites

Increase opacity and saturation when combined with our Color Portfolio,



## Design Collection Colors

Curated by our in-house designers to create a new perspective on color & pattern in harmony.

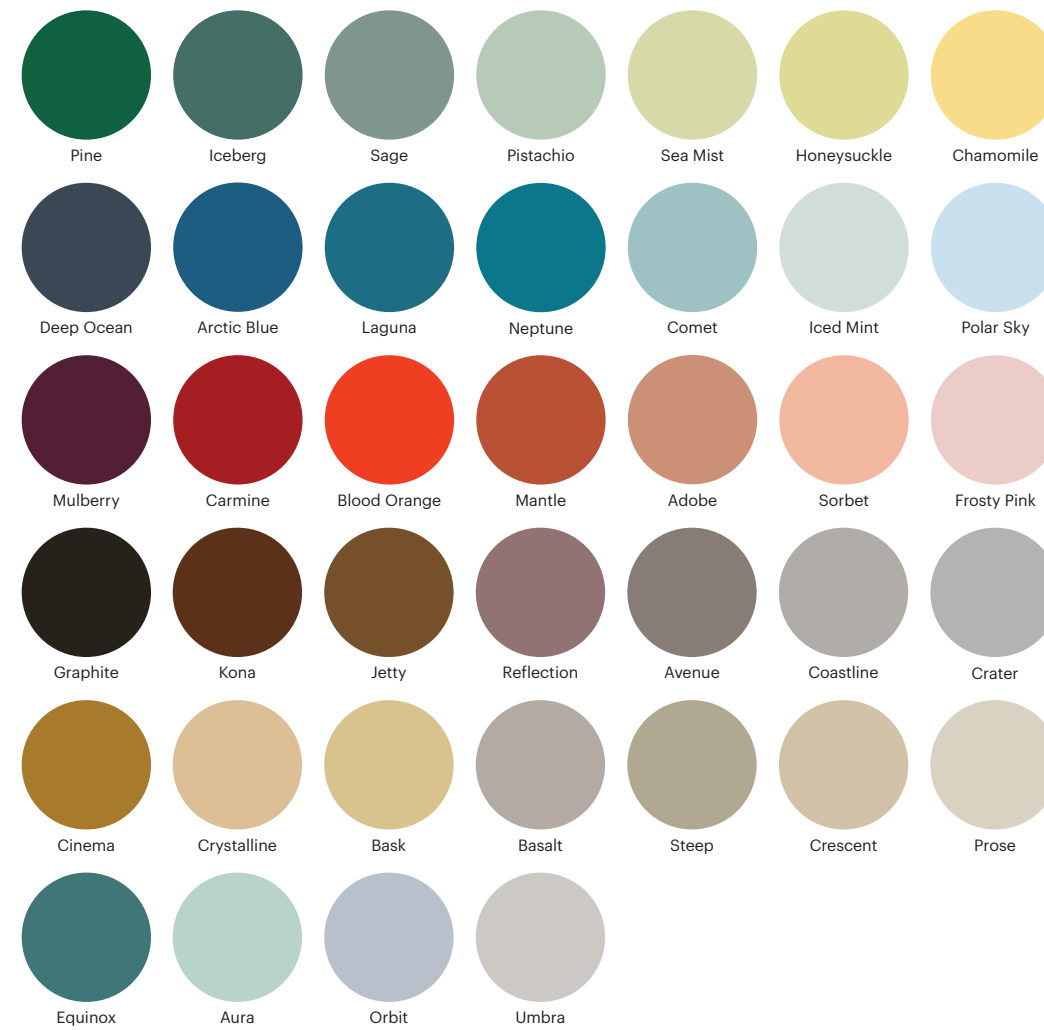



## Sola Felt Colors

Sola is an acoustic felt made from 50% post-consumer recycled PET. (Used for all acoustic solutions)

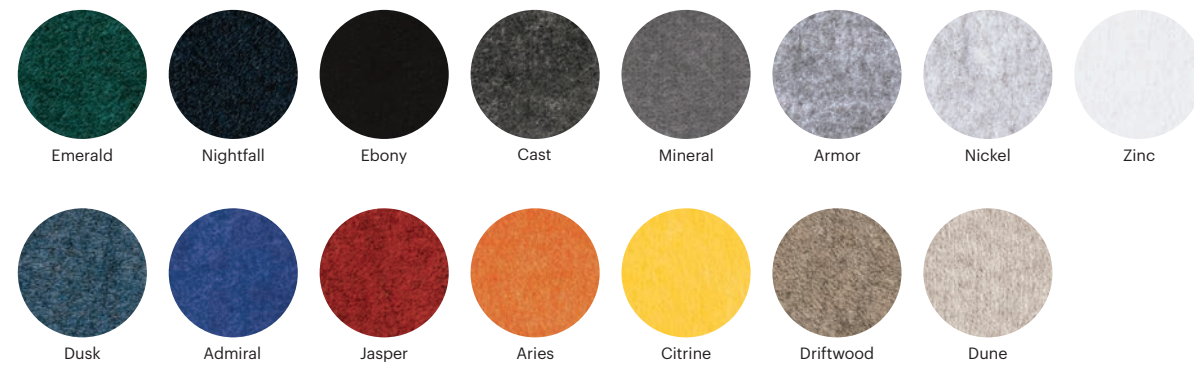

## Divide Partitions Hardware Finishes

All Divide Partition configurations come standard with Clear Anodized aluminum finish hardware, but can also be customized with thirteen powdercoated color options.

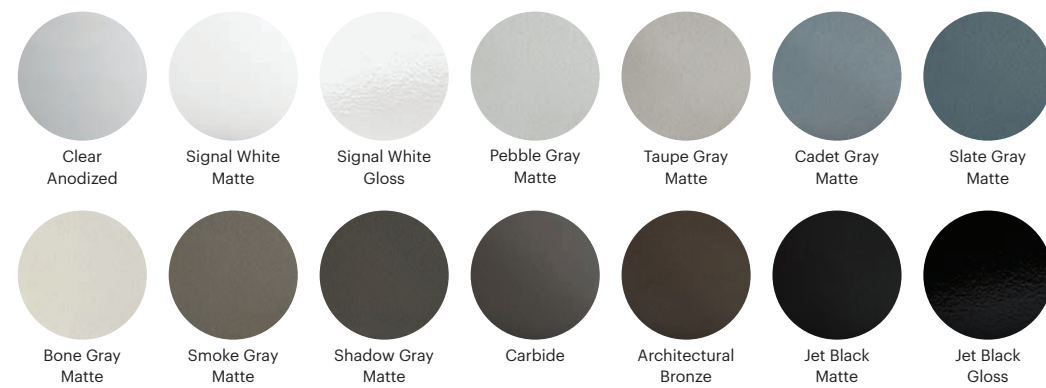

## Markerboard Colors

Customize to your workspace with six colors and three aluminum frame options.

### Markerboard Color Options

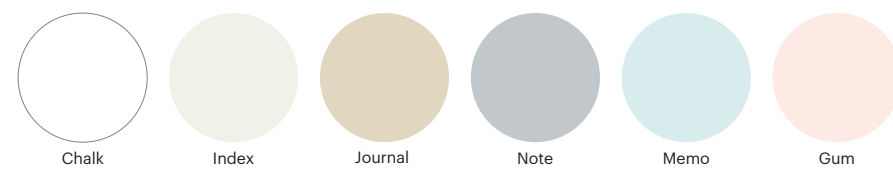

### Frame Color Options

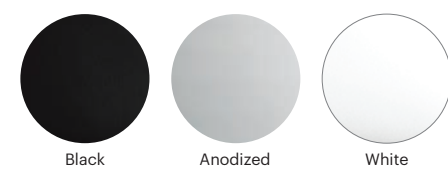

## Divy Patterns

A grouping of closely fitting geometric shapes make up the six pattern options available in the Divy collection. From subtle to complex, there's a pattern for every space.

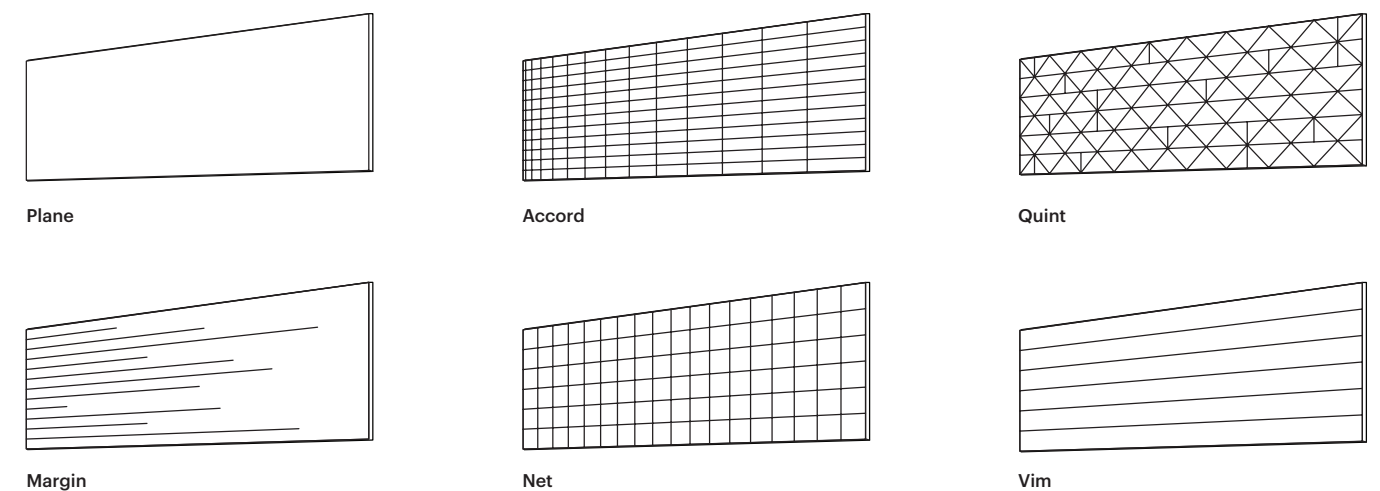
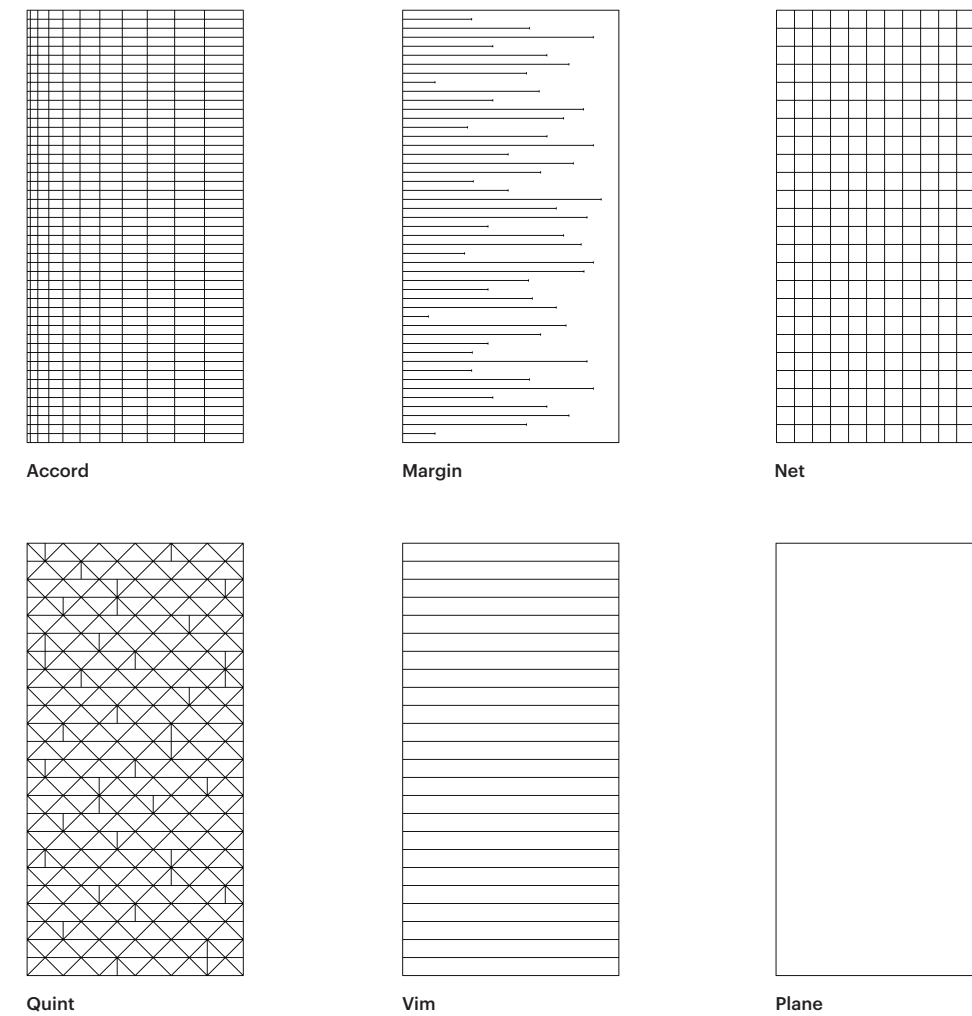





Mingle | Panel

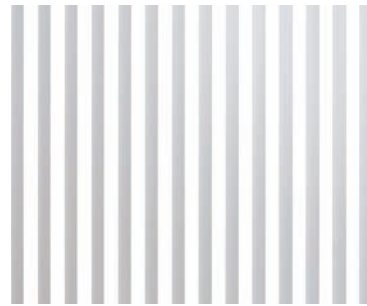

Pinstripe | Panel



Tread | Panel



Switch | Panel



Chisel | Panel



Ray | Panel



Motion | Panel



Bub | Panel



Agile | Panel



Trig | Panel



Luxe | Panel



Dash | Panel



Braid | Panel



Crest | Panel

## Profile Patterns

Profile is the most modular design solution we've ever created. Use it to transform walls into unlimited expressions of your creativity.

Visit [3-form.com/profile](https://3-form.com/profile) for more details.



Meridian | Panel



Band | Panel



Veer | Panel



Burst | Panel



Zing | Panel

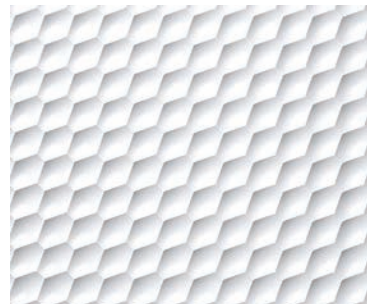

Nod | Panel



Pleat | Panel

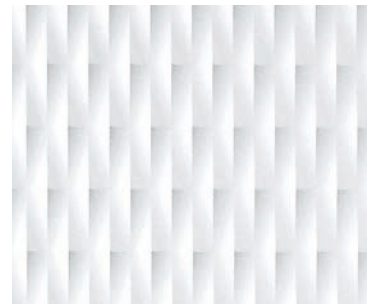

Prism | Panel

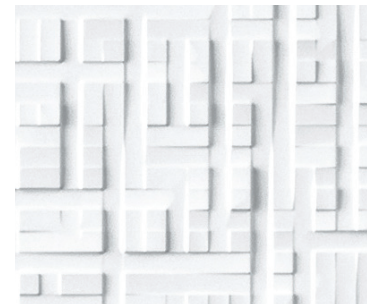

Metro | Panel

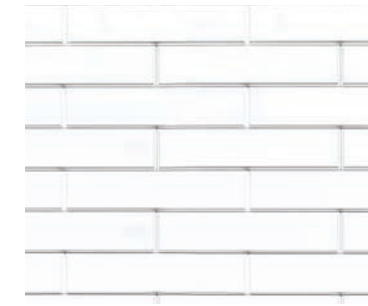

Flank | Tile



Subway | Tile



Quarry | Tile



Chasm | Panel



Metric | Panel



Carve | Panel



Stria | Panel



Glide | Tile



Verve | Tile



Swoon | Tile



At 3form® we believe in Smart Design for a Better World.  
Our approach promotes craftsmanship, community,  
sustainability, and respect for the environments where  
we work and live.

© 2021 3form Elements, LLC

North America  
800.726.0126

EMEA  
EMEA@3-form.com

3-form.com



Printed on recycled paper  
3-form.com/Align



The following marks depicted herein are registered trademarks of 3form, LLC: 3form, Chroma, Edge, Hush Blocks, Hush Clad, Profile, Seeyond, Sola Felt, Versa, and Varia. All other words, names, symbols, devices, or combinations thereof used herein that identify and distinguish 3form goods and services constitutes a trademark or trade dress of 3form, LLC, including but not limited to: Clario, Dello, Divy, Flek, Mobi, Tetria, and Velo.

This booklet, the panels, samples, colors, and layouts shown herein are 3form intellectual property, and may be the subject of one or more U.S. or international patents or patents pending.

Please see 3-form.com/IP for more information.